

ROZVÁDĚČ
SWITCHBOARD
SCHALTSCHRANK

3PE AC 400V, 50Hz

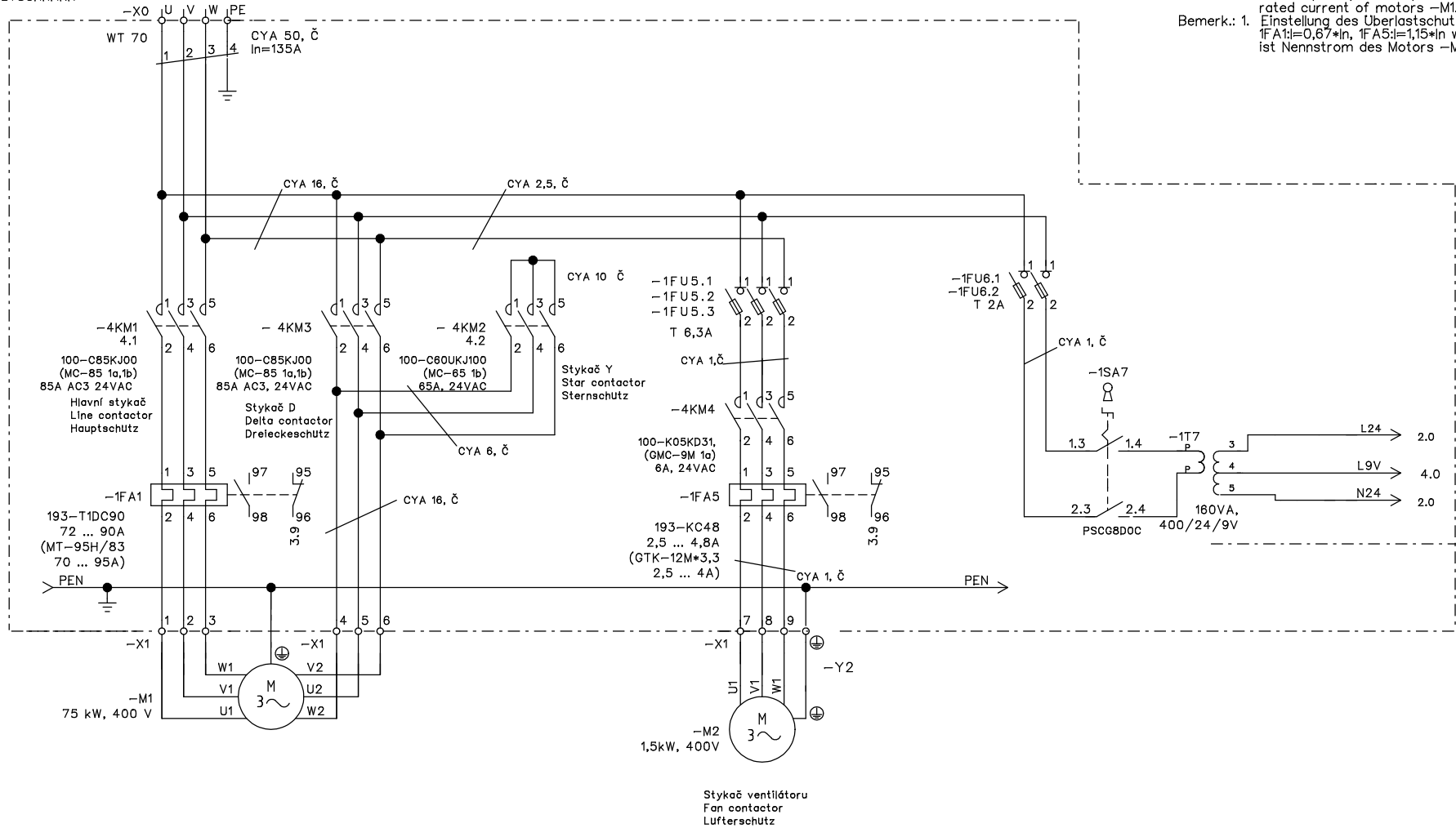

Pozn.: 1. Nastavení nadproud ochran:
1FA1:=0,67*In, 1FA5:=1,15*In kde In je
jmen.proud mot.-M1,-M2
Note.: 1. Setting of overcurrent protection
1FA1:=0,67*In, 1FA5:=1,15*In where In is
rated current of motors -M1,-M2
Bemerk.: 1. Einstellung des Überlastschutz
1FA1:=0,67*In, 1FA5:=1,15*In wo In
ist Nennstrom des Motors -M1,-M2

Datum 1.4.2013
Kreslil Ing. Hůlka
Zkoušel Ing. Hůlka

KOMPRESOR
COMPRESSOR
SMT-F

Akce: ATMOS Chrást spol. s r.o.
Typ: Hlavní obvody
Main circuits
Hauptschaltbild

Počet listů:
Number of pages: 6
Blattzahl:

List:
Page: 1
Blatt:

Výkres:
Drawing No.: At 401 167S
Zeichnung No.:



Atmos Chrást s.r.o.
tel.377 880 457, fax 377 945 379
e-mail: hulka@atmos-chrast.cz

Revize	Datum	Podpis
Revision	Date	Signature
Revision	Datum	Unterschrift

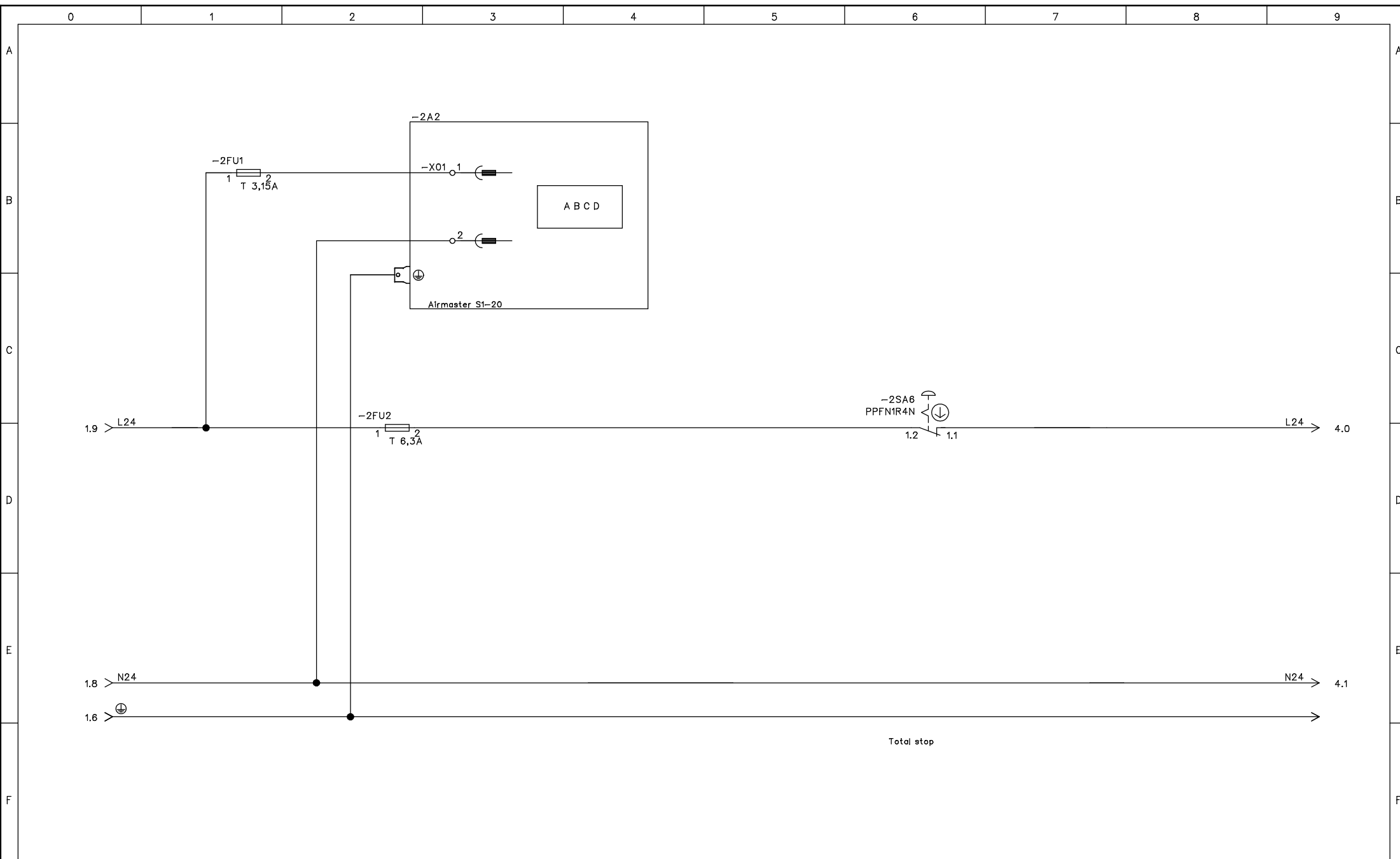

Total stop

			Datum	1.4.2013	Akce: ATMOS Chrást spol. s r.o.			Počet listů:	6	List:	2
			Kreslil	Ing. Hůlka	Typ: Pomocné obvody			Number of pages:	6	Page:	2
			Zkoušel	Ing. Hůlka	Auxiliary circuits			Blattzahl:		Blatt:	
Revize	Datum	Podpis				Výkres:			At 401 167S		
Revision	Date	Signature				Drawing No.:			At 401 167S		
Revision	Datum	Unterschrift				Zeichnung No.:			At 401 167S		



Atmos Chrást s.r.o.
tel.377 880 457, fax 377 945 379
e-mail: hulka@atmos-chrast.cz

-2A2

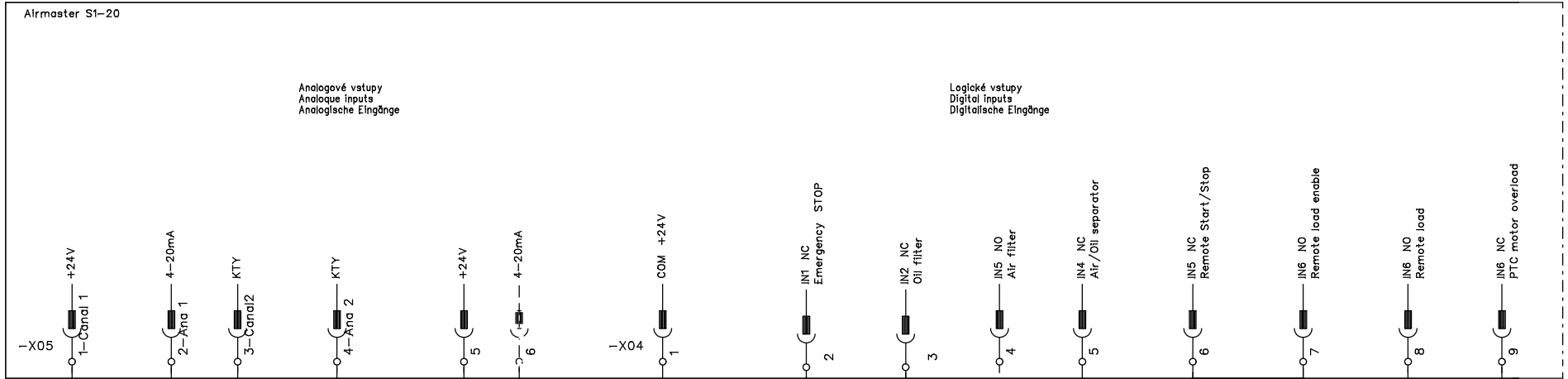

Analogové vstupy
Analog inputs
Analogische Eingänge

Logické vstupy
Digital inputs
Digitalische Eingänge

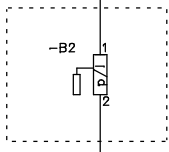

0-16 bar / 4 -20 mA

Snímač tlaku vzduchu
Air pressure sensor
Luftdruckfühler

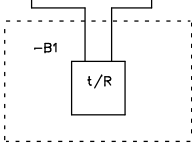

0-100°C

Snímač teploty vzduchu
Air temperature sensor
Lufttemperaturfühler

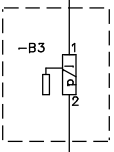

0-16 bar / 4 -20 mA

Vnitřní snímač
tlaku vzduchu
Internal air
pressure sensor

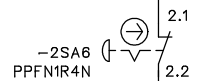

TOTAL STOP



Externí START/STOP
Remote START/STOP
Fern START/STOP

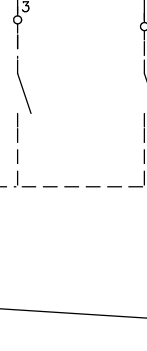

Externí ovládní tlaku
Remote control of pressures
Fernsteuerung des Druckes

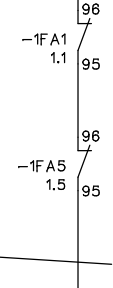

Přetížení motoru
Overload of the motors
Motor überlastet

CYA 0,5; TM

Revize	Datum	Podpis
Revision	Date	Signature
Revision	Datum	Unterschrift

Datum	1.4.2013
Kreslil	Ing. Hůlka
Zkoušel	Ing. Hůlka

**KOMPRESOR
COMPRESSOR
SMT-F**

Akce: **ATMOS Chrást spol. s r.o.**
Typ: **Analogové a logické vstupy
Analogue and digital inputs
Analogische/digital. eingänge**

Počet listů: Number of pages:	6	List: Page:	3
Výkres: Drawing No.:	At 401 167S	Blattzahl:	Blatt:
Zeichnung No.:			

ATMQS

Atmos Chrást s.r.o.
tel.377 880 457, fax 377 945 379
e-mail: hulka@atmos-chrast.cz

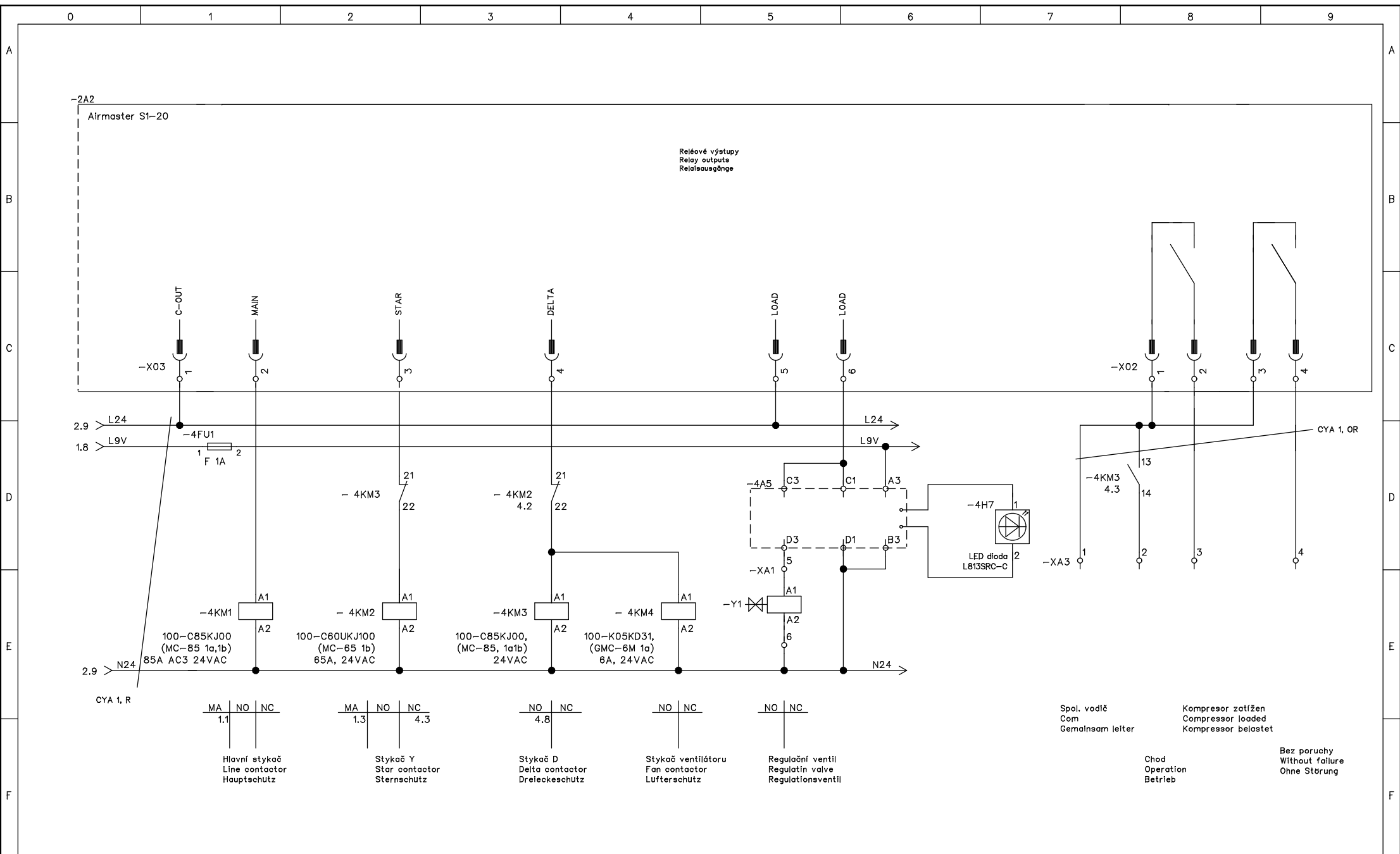

Revize	Datum	Podpis
Revision	Date	Signature
Revision	Datum	Unterschrift

Datum	1.4.2013
Kreslil	Ing. Hůlka
Zkoušel	Ing. Hůlka

KOMPRESOR
COMPRESSOR
SMT-F

Akce: **ATMOS Chrást spol. s r.o.**
Typ: **Reléové výstupy**
Relay outputs
Relais Ausgänge

Počet listů:	6	List:	4
Number of pages:	6	Page:	4
Blattzahl:		Blatt:	
Výkres:	At 401 167S		
Drawing No.:			
Zeichnung No.:			

ATMOS

Atmos Chrást s.r.o.
tel.377 880 457, fax 377 945 379
e-mail: hulka@atmos-chrast.cz

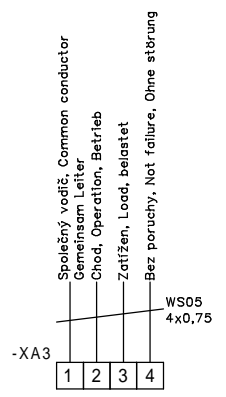
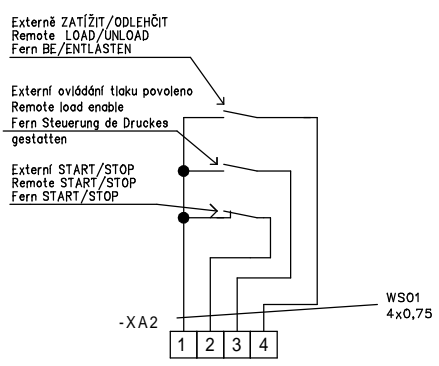
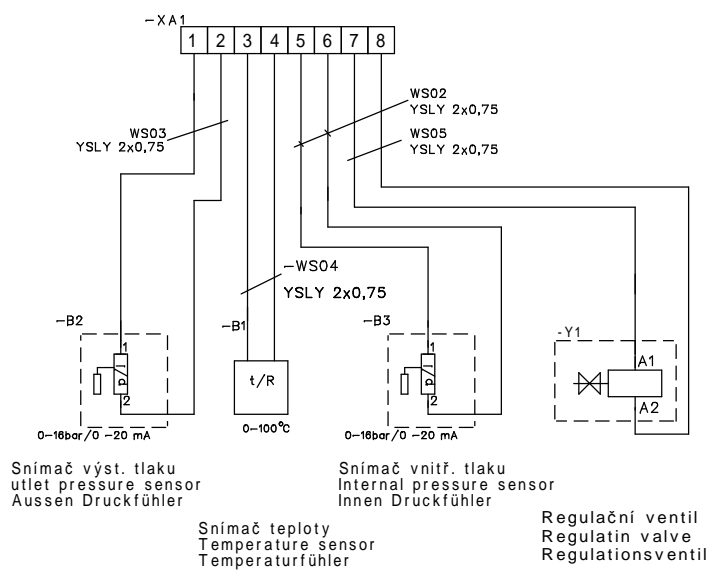
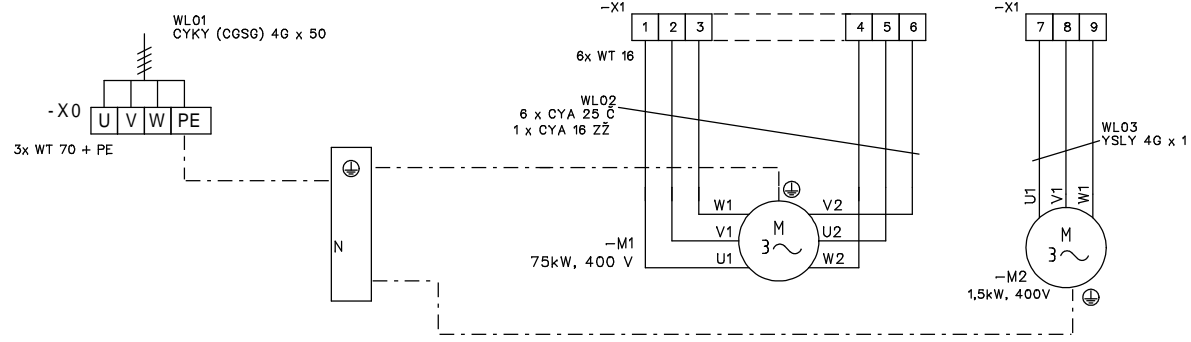

Datum	1.4.2013
Kreslil	Ing. Hůlka
Zkoušel	Ing. Hůlka
Revize	
Date	
Revision	
Datum	
Date	
Revision	
Datum	
Date	
Revision	

KOMPRESOR
COMPRESSOR
SMT-F

Akce: **ATMOS Chrást spol. s r.o.**
Typ: **Obvod. schéma vnějších spojů**
Circ. diagram of ext. terminals
Leitungschema Außenverbind.

Počet listů:
Number of pages: **6**

List:
Page: **5**

Blattzahl:
Blatt: **5**

Výkres:
Drawing No.: **At 401 167S**
Zeichnung No.:

Atmos Chrást s.r.o.
tel.377 880 457, fax 377 945 379
e-mail: hulka@atmos-chrast.cz

VYZKOUŠET OSAZENÍ, ASI POSUNOUT o cca 50mm nahoru

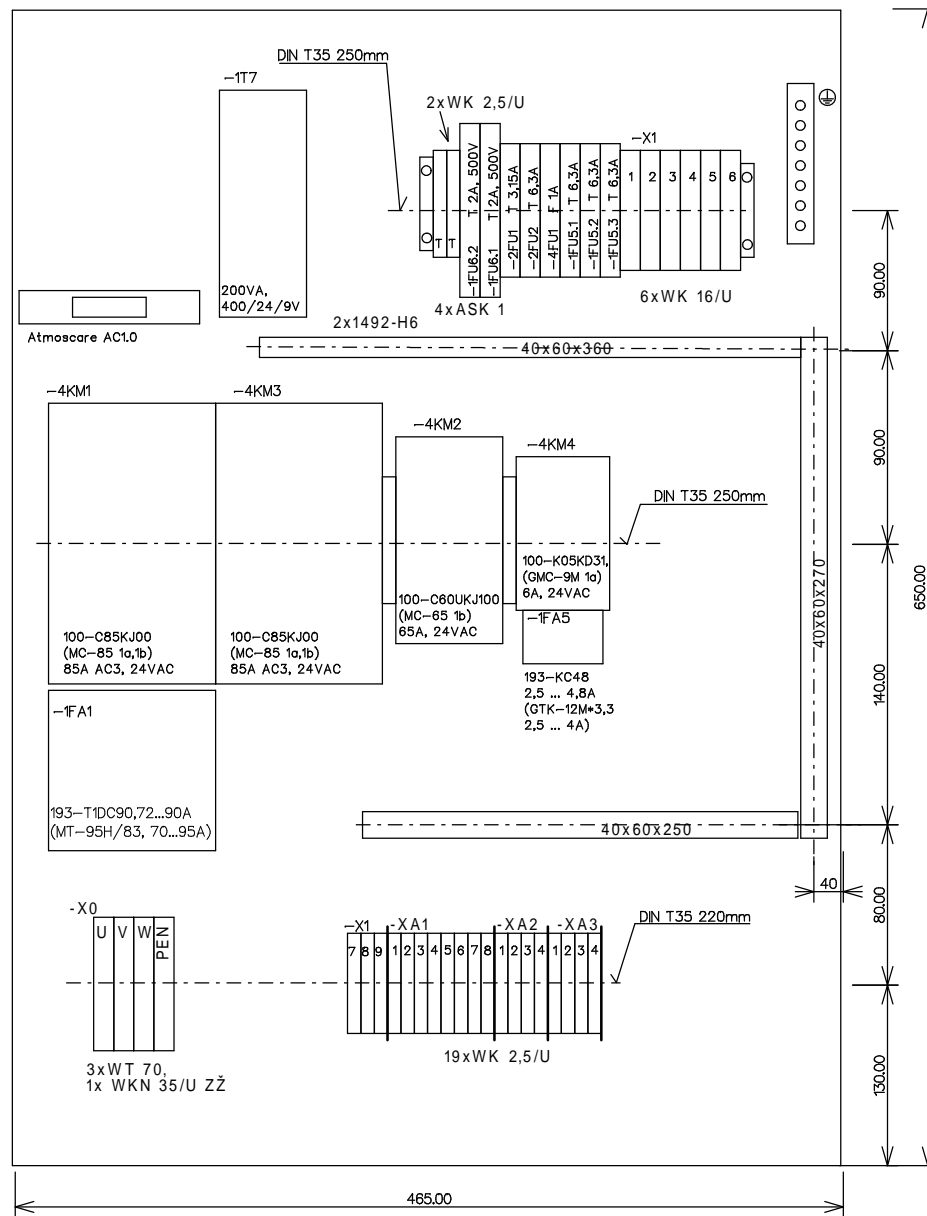

Datum 1.4.2013
Kreslil Ing. Hůlka
Zkoušel Ing. Hůlka

KOMPRESOR
COMPRESSOR
SMT-F

Akce: ATMOS Chrást spol. s r.o.
Typ: Rozmístění součástek
Dimension draught
Maßskizze

Počet listů:
Number of pages: 6
Blattzahl:

List:
Page: 6
Blatt:

Výkres:
Drawing No.: At 401 167S
Zeichnung No.:

ATMOS
Atmos Chrást s.r.o.
tel.377 860 457, fax 377 945 379
e-mail: hulka@atmos-chrast.cz

Revize	Datum	Podpis
Revision	Date	Signature
Revision	Datum	Unterschrift